

F9 PWM PST

BLACK

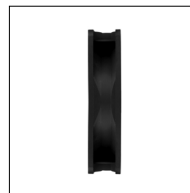

92 mm PWM PST Gehäuselüfter



Lüfter Spezifikationen

Abmessungen	92 (L) x 92 (B) x 25 (H) mm
Gewicht	85 g
Geschwindigkeit	150-1800 rpm
rpm Steuerung	Pulsweitenmodulation - PWM
Kontrolltyp	PST
Statischer Druck	1,35 mm H ₂ O
Luftstrom	43 cfm 73,1 m ³ /h
Lager	Fluid Dynamic Bearing
Kabellänge	400 mm
Anschluss	4-Pin Connector + 4-Pin Socket
Strom/Spannung	0,15 A/12 V
Anlaufspannung	8,5 V
Lautstärke	0,4 Sone
Betriebsumgebungstemperatur	0-40 °C

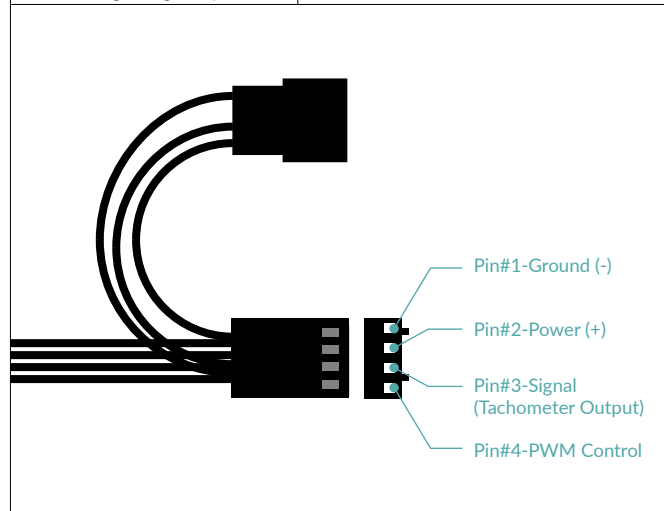

Versandinformationen Einzellüfter - Black

Box Abmessungen	96 (L) x 96 (B) x 27 (H) mm
Brutto Gewicht	106 g
SKU	ACFAN00214A
EAN	4895213702904
UPC	840033400701
Lieferumfang	F9 PWM PST x1 Montage Schrauben x4

Versandinformationen 5 Stück Value Pack - Black

Box Abmessungen	128 (L) x 103 (B) x 98 (H) mm
Brutto Gewicht	495 g
SKU	ACFAN00247A
EAN	4895213703352
UPC	840033401166
Lieferumfang	F9 PWM PST x5 Montage Schrauben x20

F9 PWM PST

BLACK



92 mm PWM PST Gehäuselüfter

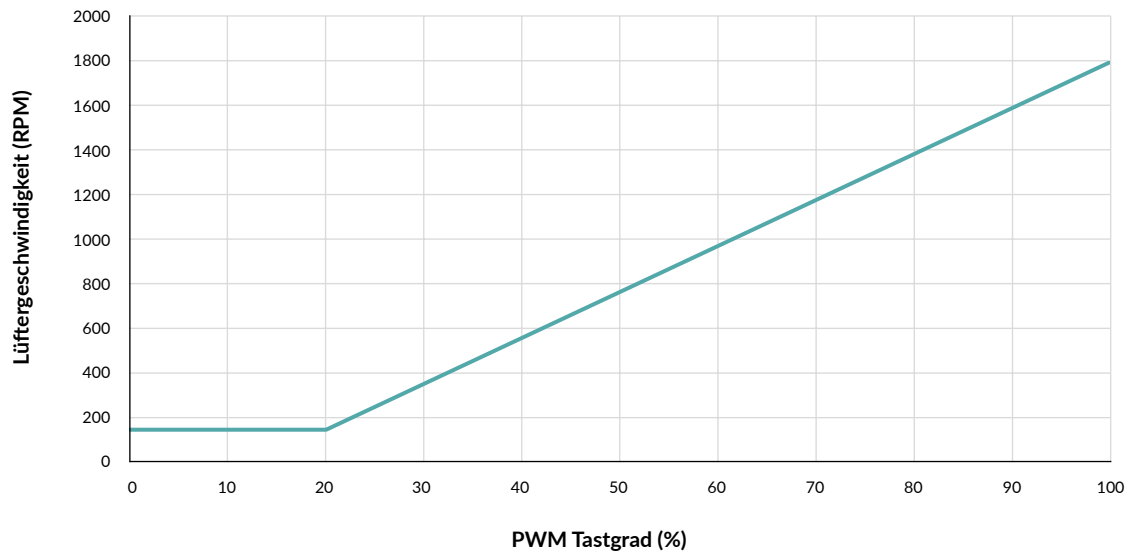
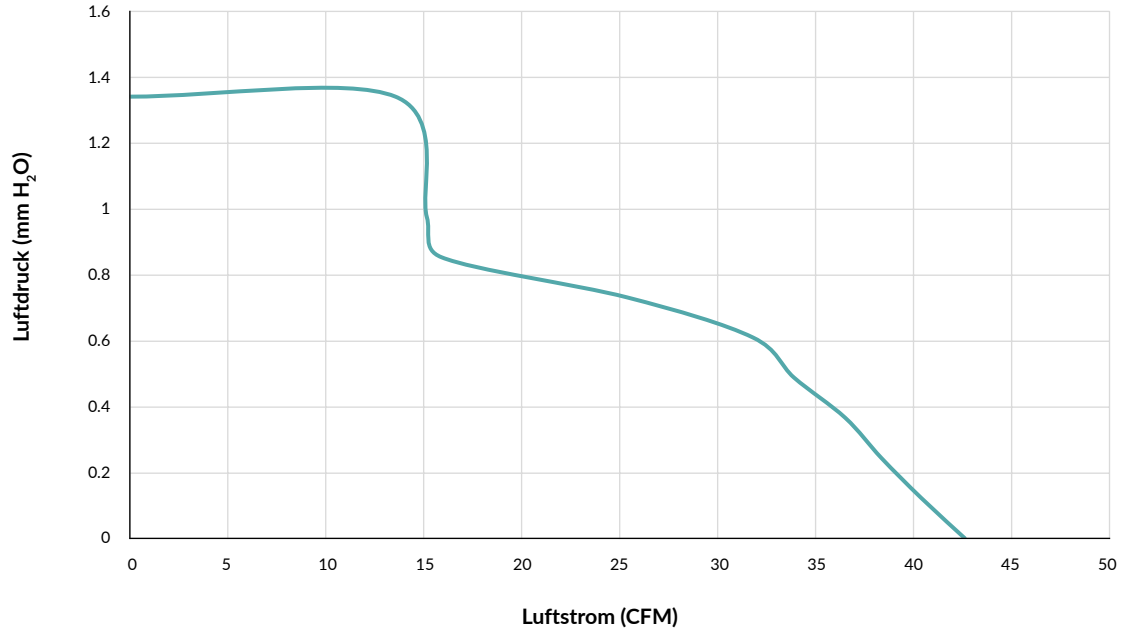

F9 PWM PST

BLACK



92 mm PWM PST Gehäuselüfter

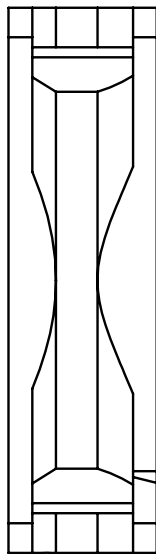
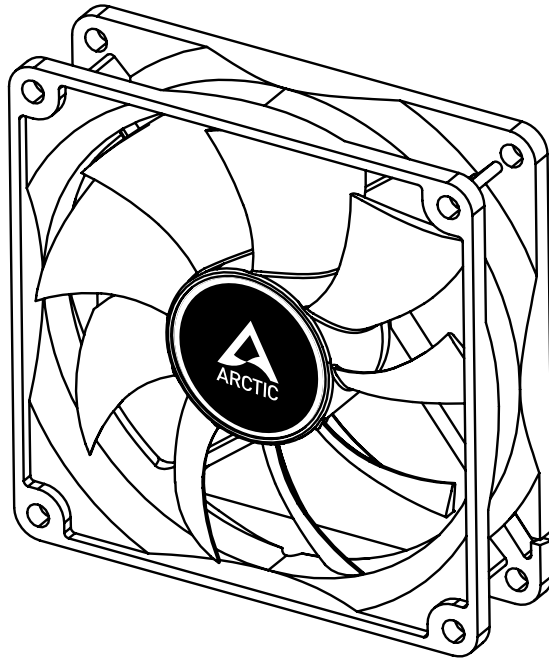

← 25mm →

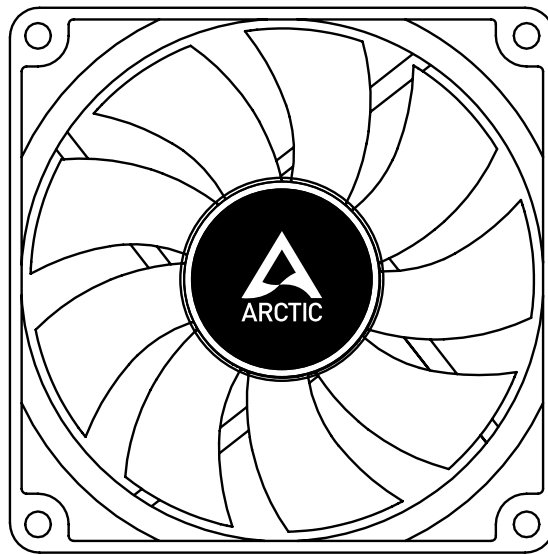

← 92mm →



92 mm

Alle Materialien sind mit den RoHS-Anforderungen kompatibel



Produktinformation



Manual