

Liquid Freezer II 420 RGB

Multikompatibler All-in-One Wasserkühler mit RGB



Allgemeine Spezifikationen

Kompatibilität	Intel® 1700, 1200, 115X, 2011-3*, 2066* *Square ILM AMD® AM5, AM4, AM3(+)
Wärmeleitpaste	MX-5 (0,8 g)
Pumpen + Lüfter	4-Pin Stecker
LED Anschluss	4-Pin 12V-G-R-B Stecker mit Y-Splitter
Gewicht	2019 g (3 Lüfter, Radiator, Pumpe, Schläuche)

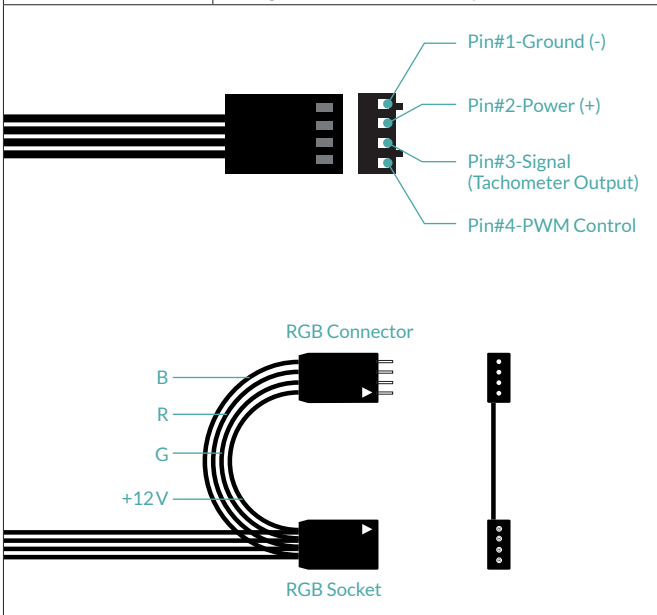

Pumpe/Cold Plate Spezifikationen

VRM-Lüfter	40 mm, 1000-3000 rpm (PWM gesteuert)
Pumpe	800-2000 rpm (PWM gesteuert)
Stromverbrauch	0,5 W-2,7 W Pumpe und VRM-Lüfter
Schlauchlänge	450 mm
Schlauchdurchmesser	Äußerer: 12,4 mm Innerer: 6,0 mm
Abmessungen	78 (L) x 53 (B) x 98 (H) mm

Lüfter Spezifikationen

Geschwindigkeit	200-1900 rpm
Luftstrom	68,9 cfm 117,06 m³/h
Statischer Druck	2 mm H ₂ O
Lautstärke	0,3 Sone
Lüfter Abmessungen	140 (L) x 140 (B) x 27 (H) mm
rpm Steuerung	Pulsweitenmodulation - PWM
Lager	Hydrodynamisches Gleitlager
Strom/Spannung	0,17 A/12 V
RGB Spezifikationen	
LEDs	12 RGB LEDs
Strom/Spannung	0,2 A/12 V

Radiator Spezifikationen

Material	Aluminium
Abmessungen	458 (L) x 38 (B) x 138 (H) mm

Versandinformationen

Garantie	6 Jahre
Box Abmessungen	447 (L) x 158 (B) x 328 (H) mm
Brutto Gewicht	2788 g
SKU	ACFRE00110A
EAN	4895213703390
UPC	840033401203

Liquid Freezer II 420 RGB

Multikompatibler All-in-One Wasserkühler mit RGB

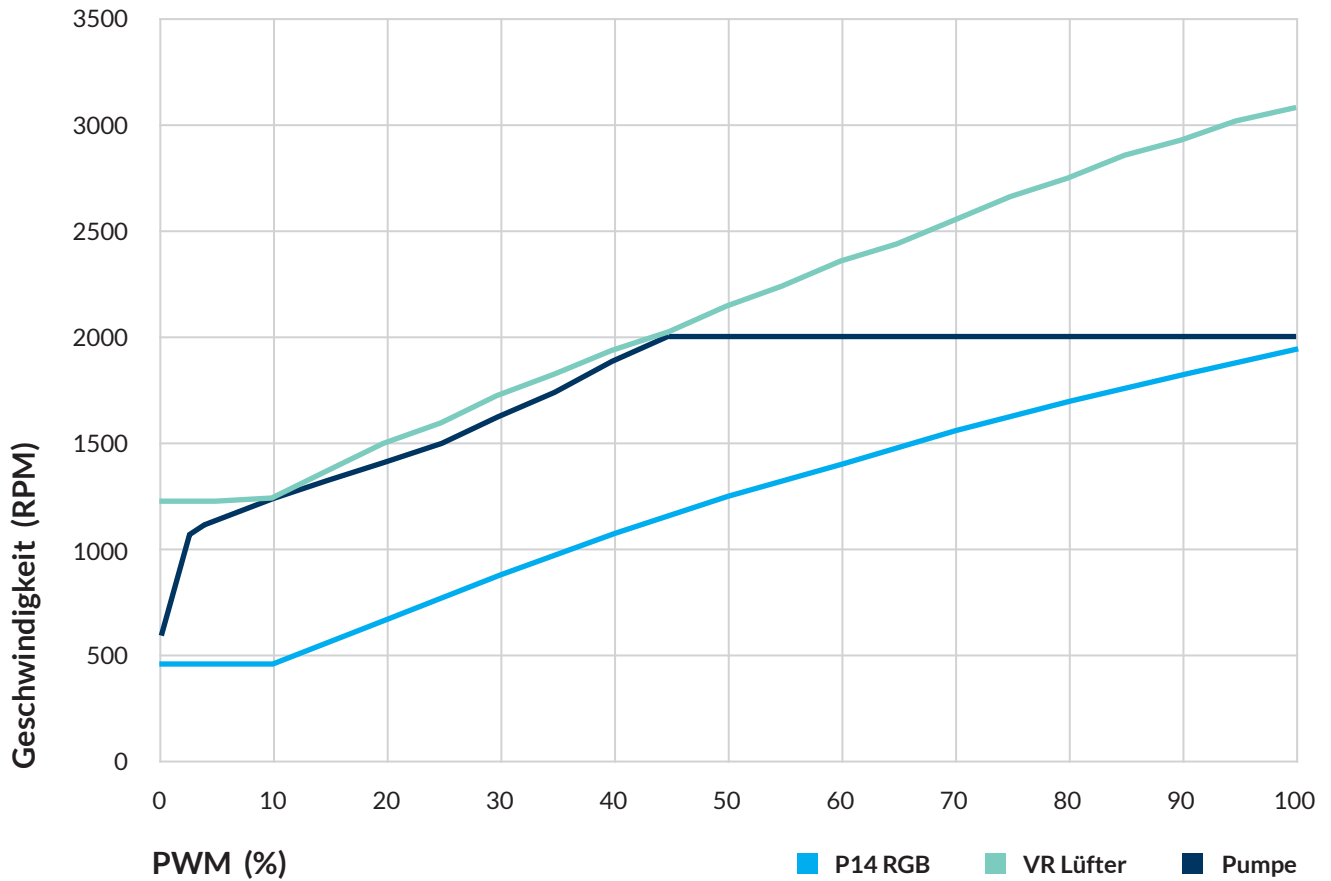

Liquid Freezer II 420 RGB

Multikompatibler All-in-One Wasserkühler mit RGB

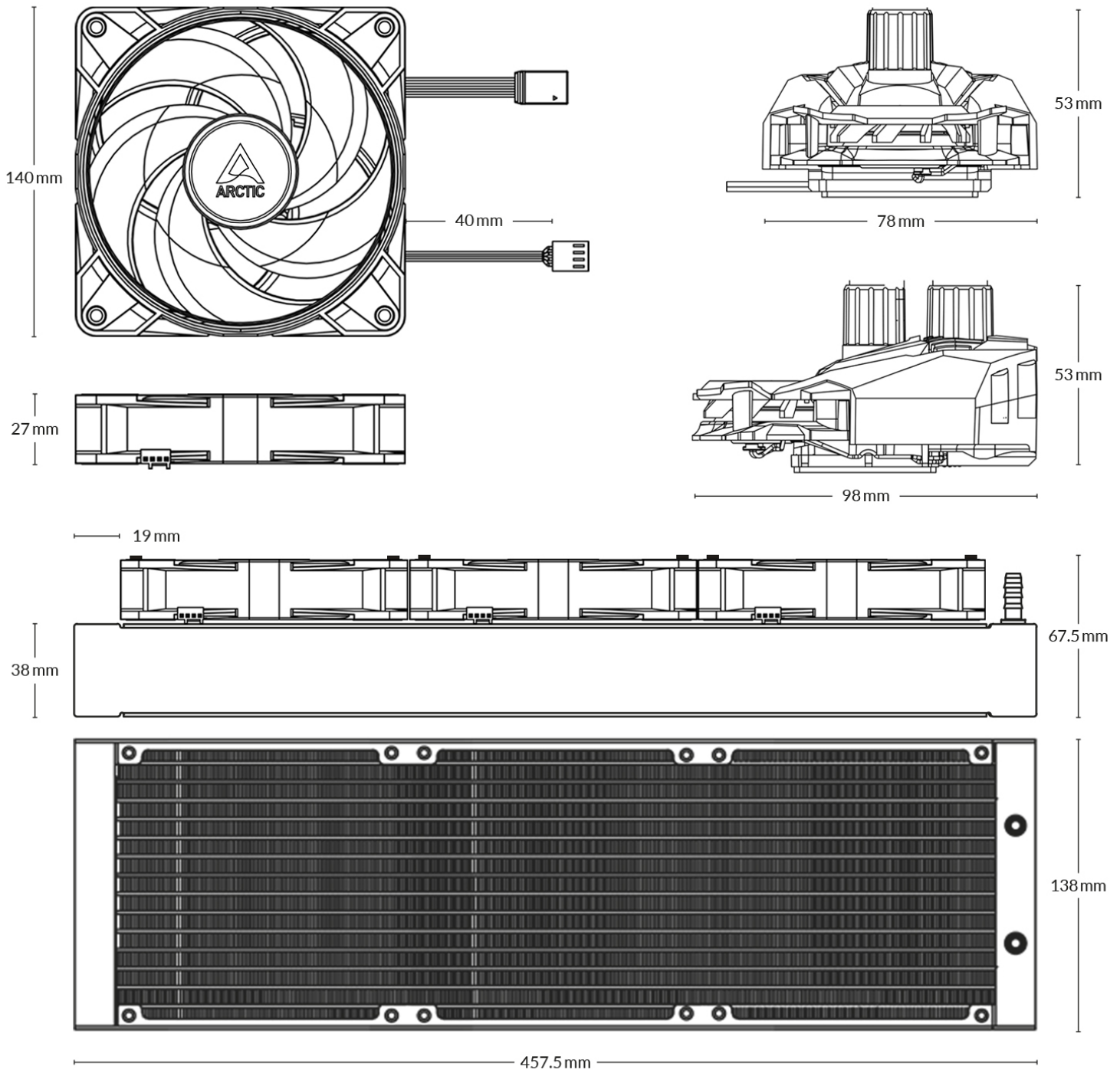

Alle Materialien sind mit den RoHS-Anforderungen kompatibel



Produktinformation



Manual