

P12 PWM PST CO

120 mm PWM PST Gehäuselüfter für Dauerbetrieb

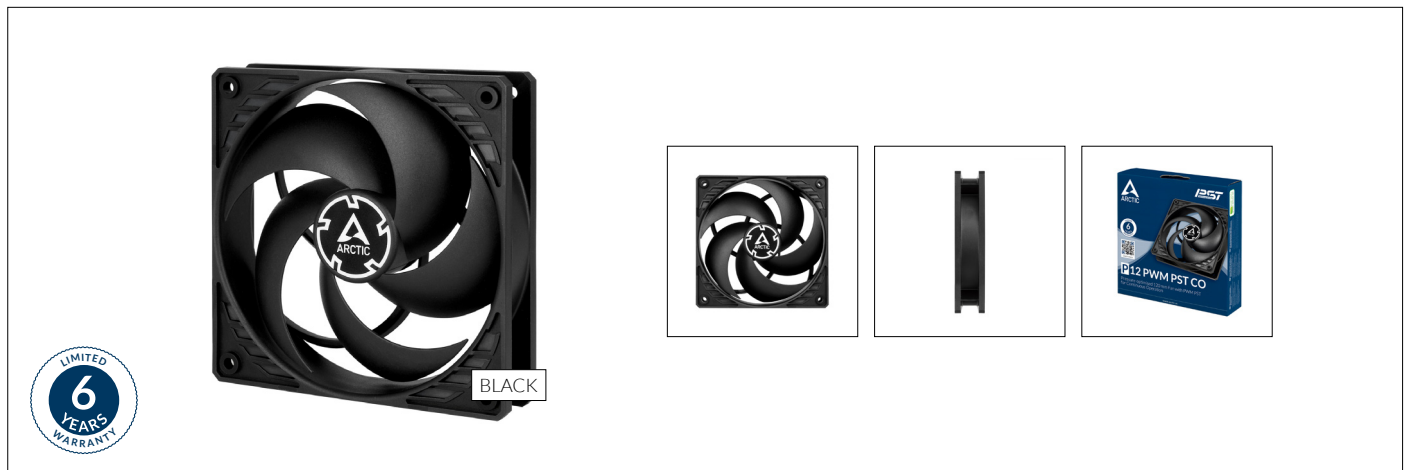

Lüfter Spezifikationen

Abmessungen	120 (L) x 120 (B) x 25 (H) mm
Gewicht	145 g
Geschwindigkeit	200-1800 rpm, 0 rpm <5% PWM
rpm Steuerung	Pulsweitenmodulation - PWM
Statischer Druck	2,20 mmH ₂ O
Luftstrom	56,3 cfm 95,70 m ³ /h
Lager	Dual Ball Bearing
Kabellänge	400 mm
Anschluss	4-Pin Stecker + 4-Pin Sockel
Strom Spannung	0,1 A 12 V
Anlaufspannung	3,9 V
Lautstärke	0,3 Sone
Betriebsumgebungstemperatur	0-40 °C

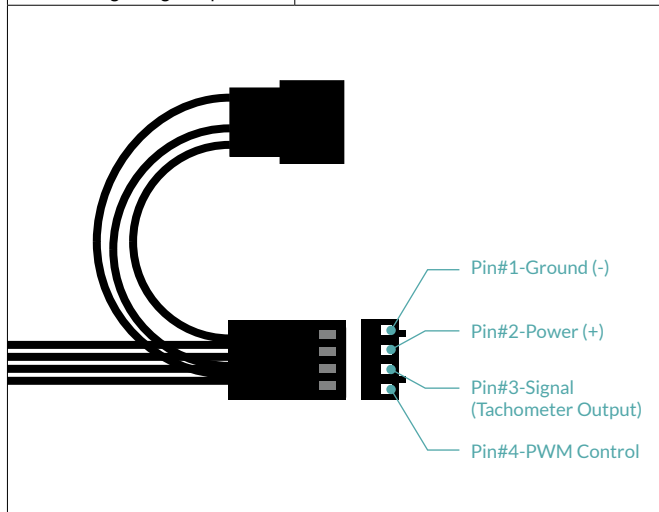

Versandinformationen Einzellüfter - Black

Box Abmessungen	123 (L) x 123 (B) x 27 (H) mm
Brutto Gewicht	180 g
SKU	ACFAN00121A
EAN	4895213701358
UPC	872767009301
Lieferumfang	P12 PWM PST CO x1 Montage Schrauben x4

P12 PWM PST CO

120 mm PWM PST Gehäuselüfter für Dauerbetrieb

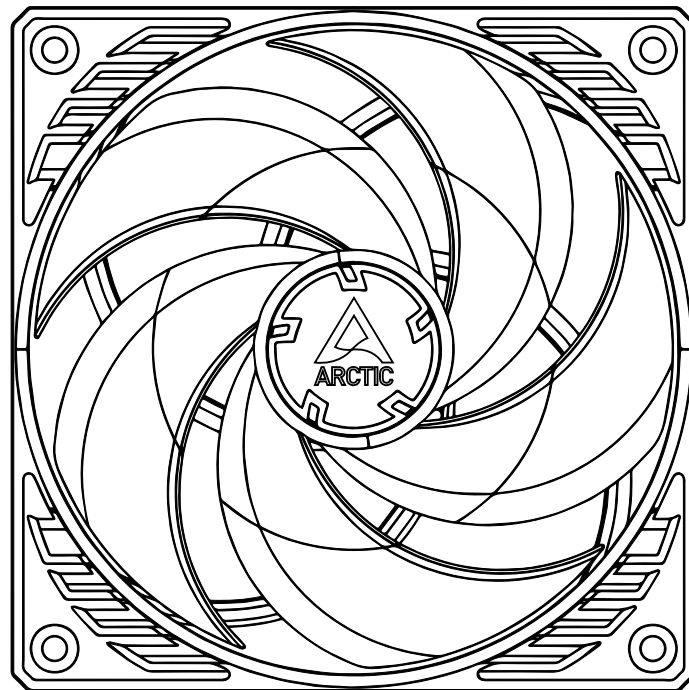

120 mm

120 mm

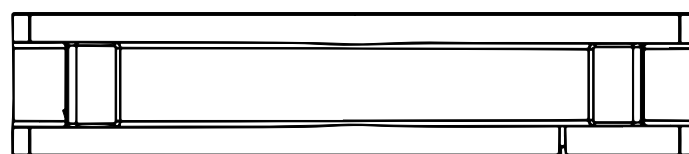

25 mm



Alle Materialien sind mit den RoHS-Anforderungen kompatibel.

WEITERE INFORMATIONEN

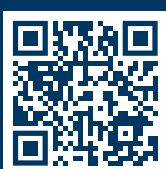

ANLEITUNGEN

